

FASTON Tabs

312 and 250 Series (High Temperature 700° F / 371° C Max.)

TE offers a variety of FASTON tabs in an assortment of configurations. The product line includes various weld type tabs, stud mounted tabs and wire crimp tabs. Also included in the product offering are high temperature tabs and test tabs.

The TE high-temperature tab is designed to crimp to heating element wire. The tab end protrudes through a ceramic/high-temperature housing for mating with either a standard 250 or 312 FASTON receptacle.

Stock Thickness — .032 [0.81]

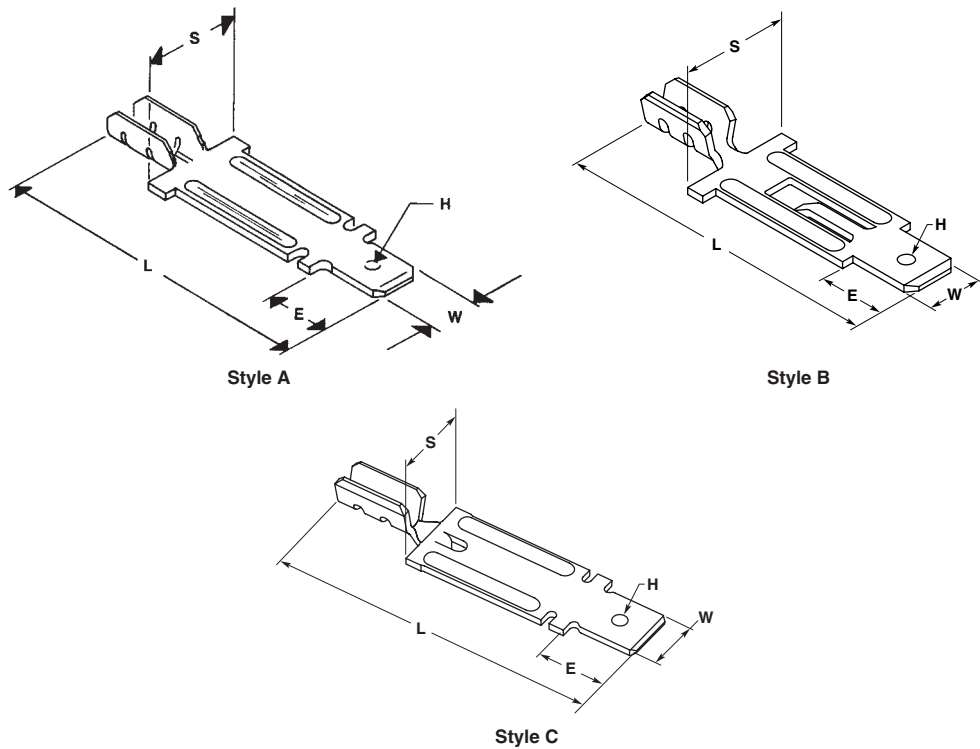

Series	Solid Wire Range AWG	Style	Tab Thickness	Dimensions					Material and Finish	Terminal Part No. ¹
				L	W	E	S	H		
312	22-15	A	.032 0.81	1.570 39.88	.312 7.92	.387 9.83	.500 12.70	Hole	Nickel Plated Steel	63300-1
		C	.032 0.81	1.570 39.88	.312 7.92	.375 9.53	Hole	Nickel Plated Steel	63390-1	
250	22-15	A	.032 0.81	1.500 38.10	.250 6.35	.312 7.92	.500 12.70	Dimple	Nickel Plated Steel	63301-1
		A	.032 0.81	1.500 38.10	.250 6.35	.312 7.92	.500 12.70	Hole	Nickel Plated Steel	63522-1
250	20-15	B	.032 0.81	1.500 38.10	.250 6.35	.312 7.92	.500 12.70	Dimple	Nickel Plated Steel	63104-1
		C	.032 0.81	1.500 38.10	.250 6.35	.312 7.92	.370 9.40	Dimple	Nickel Plated Steel	1217006-1

¹ Contact technical support for tooling application.

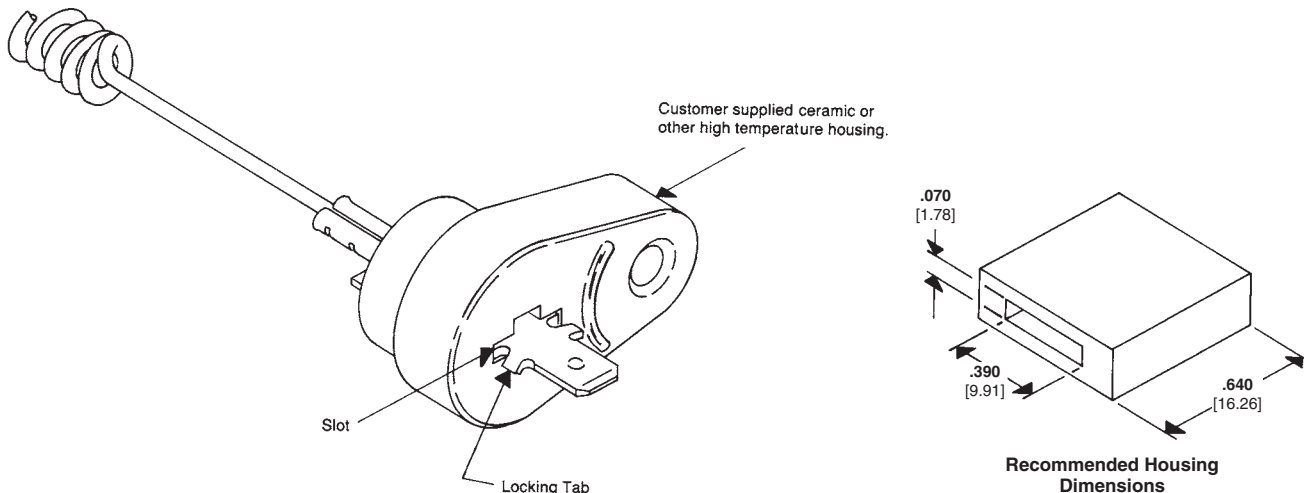

Note: All part numbers are RoHS compliant.

FASTON Tabs (Continued)

250 Series Wire Crimp Tabs

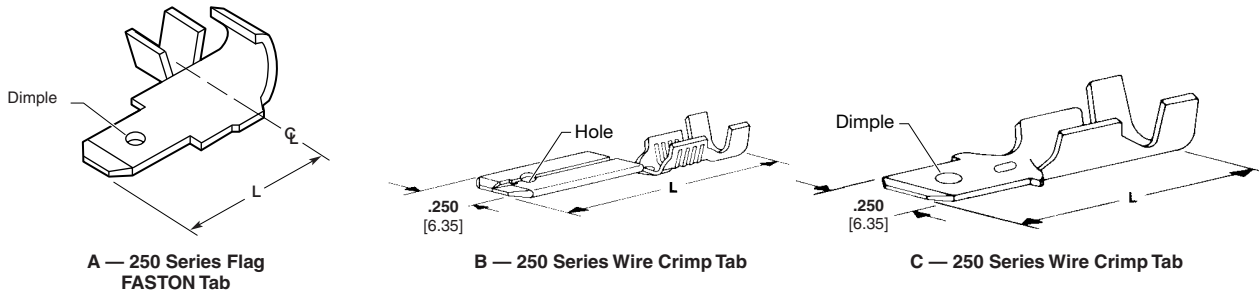

Wire Range AWG	Style	Tab Thickness	Insulation Diameter	Material and Finish	Stock Thickness	L (Overall Length)	UL	RU	SF	Terminal Part No.
22-18	B	.032 0.81	.080-.120 2.03-3.05	Brass	.015 0.38	.815 20.70	—	X	X	42475-3
		.032 0.81	.080-.120 2.03-3.05	Brass, Tin Plated	.015 0.38	.815 20.70	—	X	X	42475-4
18-14	A	.032 0.81	.080-.125 2.03-3.18	Brass, Tin Plated	.032 0.81	.500 12.70	X	—	X	42770-2
	B	.032 0.81	.110-.150 2.79-3.81	Brass	.015 0.38	.810 20.57	—	X	X	42474-3
		.032 0.81	.110-.150 2.79-3.81	Brass, Tin Plated	.015 0.38	.810 20.57	—	X	X	42474-4
	C	.032 0.81	.120-.170 3.05-4.32	Brass	.032 0.81	.775 19.69	X	—	X	41411
		.032 0.81	.120-.170 3.05-4.32	Brass, Tin Plated	.032 0.81	.775 19.69	X	—	X	41412
	14-12	B	.032 0.81	.110-.170 2.79-4.32	Brass, Tin Plated	.015 0.38	.810 20.57	—	X	X
.032 0.81			.110-.170 2.79-4.32	Brass, Silver Plated	.015 0.38	.810 20.57	—	X	X	61362-2

¹ Hole.

205 Series Wire Crimp Tabs

Stock Thickness — .020 [0.51]

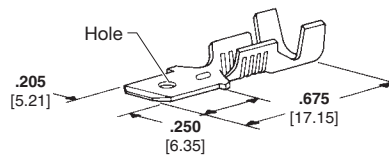

A — 205 Series Wire Crimp Tab

Wire Range AWG	Style	Tab Thickness	Insulation Diameter	Material and Finish	UL	RU	SF	Terminal Part No.
18-14	A	.020 0.51	.120-.150 3.05-3.81	Brass, Tin Plated	X	—	X	62531-1
		.020 0.51	.120-.150 3.05-3.81	Brass, Tin Plated	X	—	X	63223-1 ¹

¹ No hole.

Note: All part numbers are RoHS compliant.

FASTON Tabs (Continued)

187 Series Wire Crimp Tabs

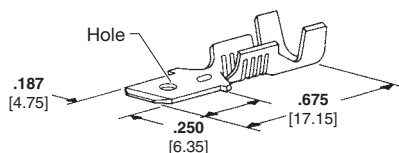

A — 187 Series Wire Crimp Tab

Wire Range AWG	Style	Tab Thickness	Insulation Diameter	Material and Finish	Stock Thickness	UL	RU	SR	Terminal Part No.
22-18	A	.020 0.51	.080-.120 2.03-3.05	Brass, Tin Plated	.020 0.51	X	—	X	42490-3
		.020 0.51	.080-.120 2.03-3.05	Brass	.020 0.51	X	—	X	42490-4
18-14	A	.020 0.51	.120-.150 3.05-3.81	Brass	.020 0.51	X	—	X	60850-1
		.020 0.51	.120-.150 3.05-3.81	Brass, Tin Plated	.020 0.51	X	—	X	60850-2
		.032 0.81	.120-.150 3.05-3.81	Brass, Tin Plated	.032 0.81	X	—	X	61687-2 ¹

¹ Premilled dual stock thickness, tab .032 [0.81], body .020 [0.51].

110 Series Wire Crimp Tabs

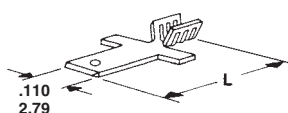

A — 110 Series Wire Crimp Tab

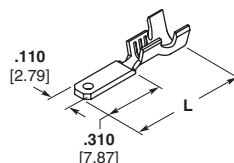

B — 110 Series Wire Crimp Tab with Insulation Support

Wire Range AWG	Style	Tab Thickness	Insulation Diameter	Material and Finish	Stock Thickness	L (Overall Length)	UL	RU	SR	Terminal Part No.
26-22	A	.020 0.51	—	Brass, Tin Plated	.020 0.51	.490 12.45	X	—	X	62887-1
		.020 0.51	—	Brass, Tin Plated over Copper	.020 0.51	.490 12.45	X	—	X	62887-2
22-18	B	.032 0.81	—	Brass, Tin Plated	.020 0.51	.490 12.45	X	—	X	63932-1 ²
		.020 0.51	—	Brass, Pre-Tin Plated	.020 0.51	.485 12.32	X	—	X	62122-1
	A	.020 0.51	—	Brass, Pre-Tin Plated	.020 0.51	.570 14.48	X	—	X	62384-1
		.032 0.81	.070-.130 1.78-3.30	Brass, Tin Plated	.032 0.81	.625 15.88	X	—	X	63138-1
20-16	A	.020 0.51	—	Brass, Pre-Tin Plated	.020 0.51	.570 14.48	—	—	—	1217118-1 ¹

¹ .052 [1.32] dia. hole.
² No insulation support.

.060 Series Wire Crimp Tabs

Stock Thickness — .032 [0.81]

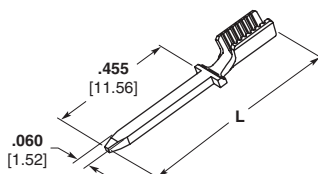

A - .060 Series Wire Crimp Tab

Wire Range AWG	Style	Tab Thickness	Insulation Diameter	Material and Finish	L (Overall Length)	UL	RU	SR	Terminal Part No.
23-19	A	.032 0.81	—	Brass, Tin Plated	.740 18.80	X	—	X	63497-1 ¹
22-16	A	.032 0.81	—	Brass, Tin Plated	.740 18.80	X	—	X	63893-1

¹ AMPLIVAR connector type serrations for magnet wire.

Note: All part numbers are RoHS compliant.

FASTON Tabs (Continued)

AMPLIVAR Tabs
(For Use with Magnet Wire)

187 Series FASTON Tabs

Board Thickness —
A = .062-.072 [1.57-1.83]

Stock Thickness —
A = .020 [0.51]
B = .032 [0.81]

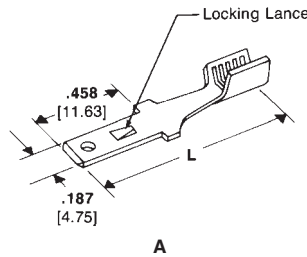

Style	Wire Range		Material	Dim. L	UL	SP	Part Number
	AWG	mm ²					
A	22-16	0.3-1.4	Tin Plated Brass	1.015 25.78	—	—	62447-1
	15-12	1.6-3.0	Tin Plated Brass	1.015 25.78	—	—	62445-1

250 Series FASTON Tabs

Stock Thickness — .032 [0.81]

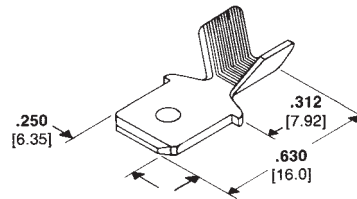

Style	Wire Range		Material	UL	SP	Part Number
	AWG	mm ²				
18-14	1.0-1.7	Tin Plated Brass	—	—	63349-1 ¹	
16-12	1.3-3.0	Tin Plated Brass	—	—	62922-1 ¹	

¹ Varnish resistant coating.

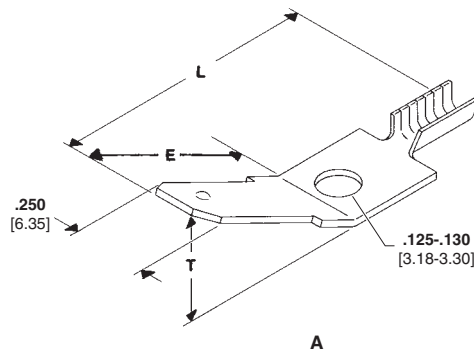

Style	Wire Range			Material	Dimensions			UL	SP	Part Number
	CMA	AWG	mm ²		L	E	T			
A	200-566	27.5-23	—	Tin Plated Brass	.580 14.73	.342 8.69	45°	—	—	63136-1

Note: All part numbers are RoHS compliant.

FASTON Tabs (Continued)

250, 205 and 187 Series FASTON Tabs

(Mates with all 250, 205 and 187 Series FASTON Receptacles)

250 and 187 Series Weld Type Tabs

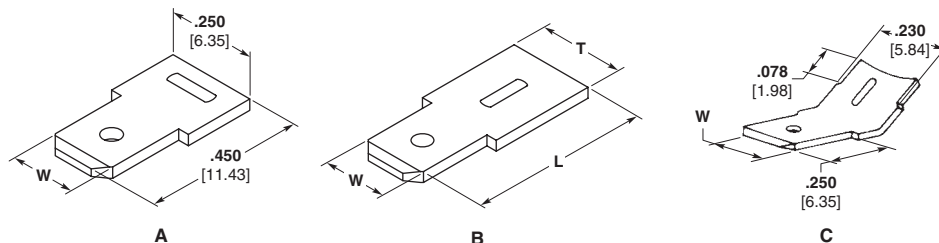

Style	Dimensions			Stock Thickness	Material and Finish	Terminal Part No.	UL	SP
	W	L	T					
A	.250 6.35	.635 16.13	.295 7.49	.032 0.81	Nickel Plated Steel	42559-1 ¹	X	X
	.187 4.75	.450 11.43	.250 6.35	.032 0.81	Nickel Plated Steel	63771-1	—	—
B	.250 6.35	.825 20.96	.375 9.53	.032 0.81	Nickel Plated Steel	1217002-1	—	—
C	.187 4.75	.250 6.35	.230 5.84	.020 0.51	Nickel Plated Steel	61960-1	X	X

¹ No weld rib.

250 Series Stud Mount Type Tabs

Stock Thickness — .032 [0.81]
Dimple (Both Sides)

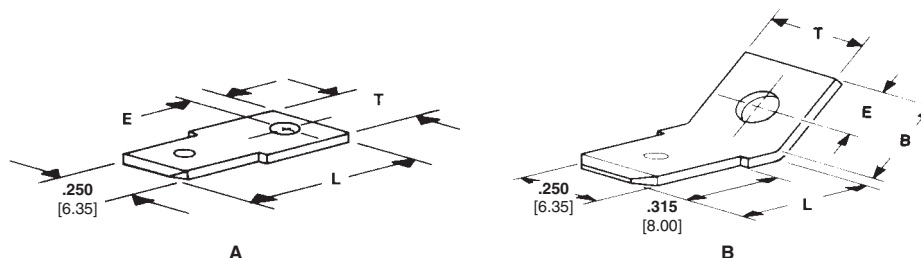

Style	Stud Diameter	Dimensions				Material and Finish	Terminal Part No.	UL	SP
		B	L	E	T				
A	.177 4.50	—	.715 18.16	.170 4.32	.295 7.49	Brass	63038-2	X	—
			.715 18.16	.170 4.32	.295 7.49	Tin Plated Brass	63038-1	X	X
	.171 4.34	—	.940 23.88	.125 3.18	.280 7.11	Brass	1217558-1	—	—
			.940 23.88	.125 3.18	.280 7.11	Tin Plated Brass	1217558-2	—	—
B	.130 3.30	.300 7.62	.400 10.16	.170 4.32	.295 7.49	Tin Plated Brass	42822-2	X	X
	.145 3.68	.300 7.62	.400 10.16	.170 4.32	.295 7.49	Tin Plated Brass	42822-4	X	X
	.171 4.34	.330 8.38	.375 9.53	.170 4.32	.295 7.49	Brass	60465-1	X	X
						Tin Plated Brass	60465-2	X	X
	.203 5.16	.330 8.38	.375 9.53	.170 4.32	.295 7.49	Tin Plated Brass	61365-1	X	X
	.197 5.00	.330 8.38	.375 9.53	.170 4.32	.295 7.49	Tin Plated Brass	61499-1	X	X

Note: All part numbers are RoHS compliant.

FASTON Tabs (Continued)

**250 Series
Stud Mount Type Tabs**

(Continued)

Stock Thickness — .032 [0.81]

Dimple (Both Sides)

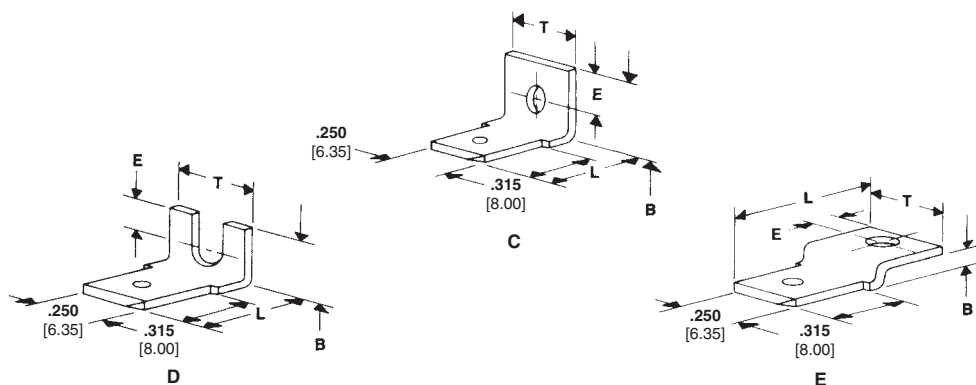

Style	Stud Diameter	Dimensions				Material and Finish	Terminal Part No.	UL	SP
		B	L	E	T				
C	.097 2.46	.250 6.35	.440 11.18	.093 2.36	.295 7.49	Brass	41339	X	X
	.130 3.30	.330 8.38	.440 11.18	.170 4.32	.295 7.49	Tin Plated Brass	42095-1	X	X
		.270 6.86	.440 11.18	.110 2.79	.295 7.49	Tin Plated Brass	42117-2	X	X
	.171 4.34	.330 8.38	.440 11.18	.170 4.32	.295 7.49	Brass	42214-1	X	X
		.313 7.95	.656 16.67	.125 3.18	.250 6.35	Tin Plated Brass	42214-2	X	X
			.472 11.99	.394 10.00	—	.295 7.49	Tin Brass	63971-1	—
D	.125 3.18	.235 5.97	.440 11.18	.125 3.18	.295 7.49	Brass	41398	X	X
	.171 4.34	.330 8.38	.440 11.18	.120 3.05	.205 5.20	Brass	62166-1	X	X
E	.130 3.30	.068 1.73	.615 15.62	.093 2.36	.295 7.49	Tin Plated Brass	42506-2	X	X

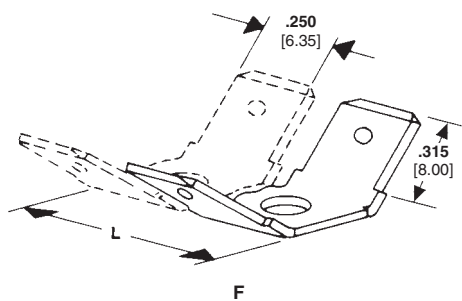

Style	Pairs	Stud Diameter	Dim. L	Material and Finish	Terminal Part No.	UL	SP
F	2	.130 3.30	.690 17.53	Tin Plated Brass	41478	X	X
		.171 4.34	.690 17.53	Brass	41617	X	X
	4	.130 3.30	1.455 36.96	Tin Plated Brass	41484	X	X

Note: All part numbers are RoHS compliant.

FASTON Tabs (Continued)

250 Series Stud Mount Type Tabs

(Continued)

Stock Thickness — .032 [0.81]

Dimple (Both Sides)

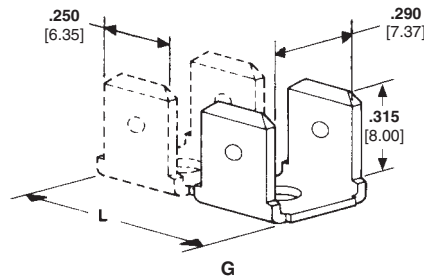

Style	Pairs	Stud Diameter	Dim. L	Material and Finish	Terminal Part No.		
G	1	.130 3.30	.315 8.00	Brass	41290	X	X
	2	.130 3.30	.690 17.53	Brass	41291	X	X
	3	.130 3.30	1.065 27.05	Brass	41292	X	X
	4	.130 3.30	1.440 36.58	Brass	41370	X	X
	1	.130 3.30	.315 8.00	Tin Plated Brass	41480	X	X
	2	.130 3.30	.690 17.53	Tin Plated Brass	41481	X	X
	3	.130 3.30	1.065 27.05	Tin Plated Brass	41482	X	X
	—	.130 3.30	—	Tin Plated Brass	42115-4 ¹	X	X
				Brass	42115-6 ¹	X	X
	1		.171 4.34	.315 8.00	Brass	41619	X
		.097 2.46	.315 8.00	Tin Plated Brass	60080-2	X	X

¹ In continuous strip-form.

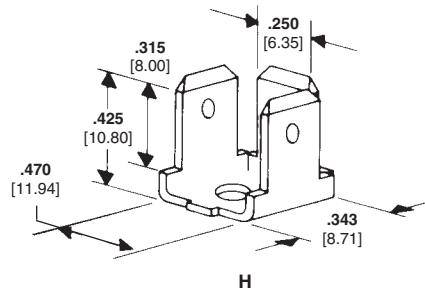

Style	Stud Diameter	Material and Finish	Terminal Part No.		
H	.130 3.30	Brass	62261-1	X	X

205 Series Stud Mount Type Tabs

Tab Thickness — .032 [0.81]

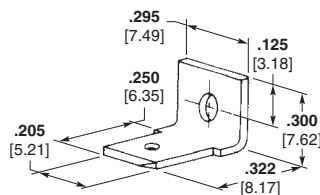

Stud Diameter	Material and Finish	Terminal Part No.		
.145 3.68	Brass	62168-1	X	X
.130 3.30	Brass	61836-1	X	X

Note: All part numbers are RoHS compliant.

FASTON Tabs (Continued)

**187 Series
Stud Mount Type Tabs —
Hole in Tab**

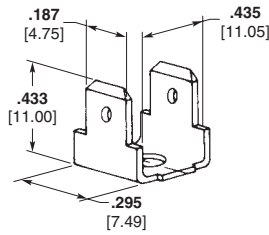

A

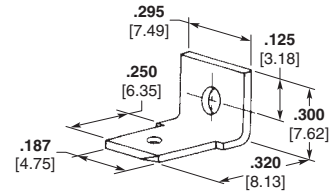

B

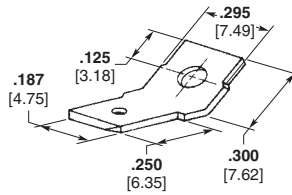

C

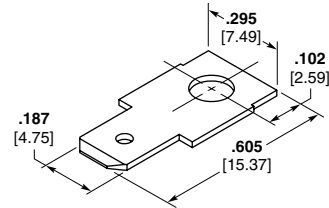

D

Style	Stud Diameter	Stock Thickness	Material and Finish	Terminal Part No.	UL	CSA
A	.130 3.30	.020 0.51	Tin Plated Brass	61951-1	X	X
	.197 5.00	.020 0.51	Tin Plated Brass	61914-1	X	X
B	.145 3.68	.020 0.51	Tin Plated Brass	61407-3	X	X
C	.130 3.30	.020 0.51	Tin Plated Brass	61761-2 ²	X	X
	.145 3.68	.020 0.51	Brass	62576-1 ²	X	X
D	.171 4.34	.020 0.51	Tin Plated Brass	61664-1 ²	X	X
	.130 3.30	.020 0.51	Tin Plated Brass	63946-1	—	—
	.145 3.68	.020 0.51	Tin Plated Brass	1742041-1	—	—

¹ Weld tab.
² Bent 45°.

Note: All part numbers are RoHS compliant.

FASTON Tabs (Continued)

250 Series Test Tabs
(Mate with all "250" Series FASTON Receptacles)

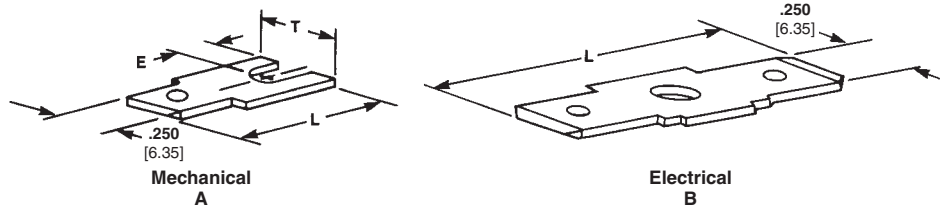

The mechanical tab is mounted onto TE gauge 100505 for testing of receptacle insertion/extraction requirements. Double-ended test tabs are also available for electrical and temperature rise testing. TE has readily available a variety of UL 310 constructed tabs for mechanical testing of FASTON, Ultra-Fast FASTON and Positive Lock receptacles. These tabs are designed for electrical test setups as outlined in UL 310 (See instruction sheet 408-7432 for recommended procedure mechanical test).

Style	Stud Diameter	Stock Thickness	Dimensions			Material and Finish	UL	CS	Terminal Part No.
			L	E	T				
A	.125 3.18	.032 0.81	.625 15.88	.125 3.18	.295 7.49	Brass	X	X	60447-1 ^{1,3}
		.020 0.51	.635 16.13	.125 3.18	.295 7.49	Brass	—	—	63633-1 ²
		.032 0.81	.625 15.88	.125 3.18	.295 7.49	Brass	—	—	63274-1 ²
B	.145 3.68	.032 0.81	1.010 25.65	—	—	Tin Plated Steel	—	—	62627-1 ³
						Brass	—	—	62627-2 ³
						Brass	—	—	62627-3 ²

¹ Mechanical test tab for use with TE gauge number 100505.

² Test tab with hole for Positive Lock.

³ Dimple.

FASTON Tabs

205 Series Test Tabs

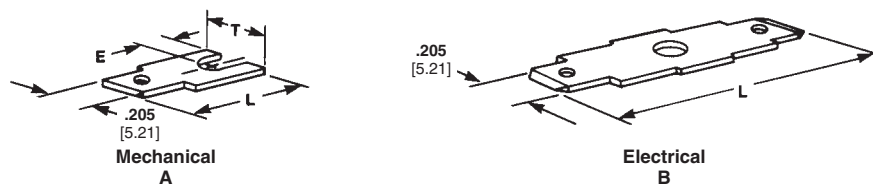

Style	Hole Diameter	Stock Thickness	Dimensions			Material and Finish	UL	CS	Terminal Part No.	
			B	L	E					T
A	.125 3.18	.020 0.51	—	.605 15.37	.090 2.29	.295 7.49	Brass	X	X	60613-1 ¹
		.032 0.81	—	.605 15.37	.090 2.29	.295 7.49	Brass	X	X	60613-2 ¹
B	.145 3.68	.020 0.51	—	1.276 32.41	—	—	Tin Plated Steel	—	—	60921-4
		.032 0.81	—	1.276 32.41	—	—	Brass	—	—	60922-1
		.020 0.51	—	1.276 32.41	—	—	Brass	—	—	60921-1
		.032 0.81	—	1.276 32.41	—	—	Tin Plated Steel	—	—	60922-5

¹ Mechanical test tab for use with TE gauge number 100505.

Note: All part numbers are RoHS compliant.

FASTON Tabs (Continued)

187 Series Test Tabs
(Mates with all "187" Series Receptacles)

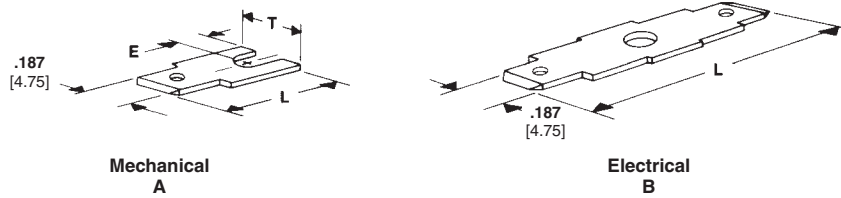

Style	Pairs	Stud Diameter	Stock Thickness	Dimensions			Material and Finish	UL	SP	Terminal Part No.	
				L	E	T					
A	—	.125 3.18	.020	.605	.090	.295	Brass	X	X	60443-1 ¹	
			0.51	15.37	2.29	7.49	Tin Plated Brass	—	—	60443-5 ¹	
			.032	0.81	15.37	2.29	7.49	Brass	—	—	63248-1 ¹
								Brass	X	X	60443-2 ¹
								Tin Plated Brass	X	X	60443-6
								Brass	—	—	63248-2
B	1	.145 3.68	.020	1.276	—	—	Tin Plated Steel	X	X	60920-4	
			0.51	32.41	—	—	Tin Plated Brass	—	—	60920-5	
			.032	0.81	32.41	—	—	Brass	X	X	62298-1
								Tin Plated Steel	X	X	62298-2

¹ Test tab with hole.

125 Series Test Tabs
(Mates with all "125" Series Receptacles)

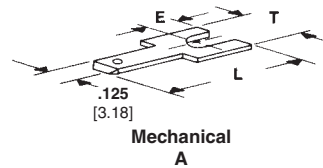

Style	Pairs	Stud Diameter	Stock Thickness	Dimensions			Material and Finish	UL	SP	Terminal Part No.
				L	E	T				
A	—	.125 3.18	.020 0.51	.570 14.48	.090 2.29	.295 7.49	Brass	—	—	63747-1

110 Series Test Tabs
(Mates with all "110" Series Receptacles)

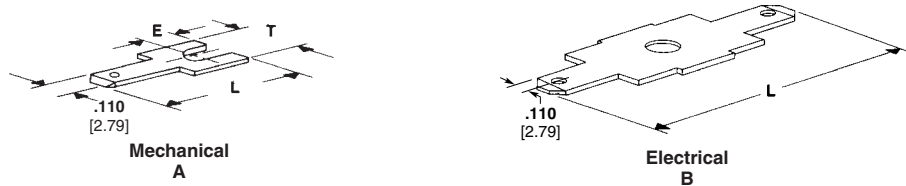

Style	Stud Diameter	Stock Thickness	Dimensions			Material and Finish	UL	SP	Terminal Part No.	
			L	E	T					
A	.125 3.18	.020	.570	.090	.295	Brass	X	X	62061-1	
		0.51	14.48	2.29	7.49	Brass	—	—	62061-2	
		.032	0.81	14.48	2.29					7.49
		0.41	14.48	2.29	7.49	Brass	—	—	62061-3	
		B	.145 3.68	.020	1.151	—	—	Tin Plated Steel	X	X
0.51	29.24			—	—	Brass	X	X	62628-2	
.020	0.51			29.24	—					—

Note: All part numbers are RoHS compliant.

FASTON Tab Adapters

250 Series

Fits Tab — .032 [0.81]

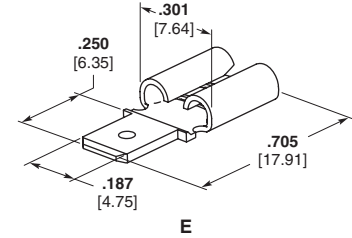
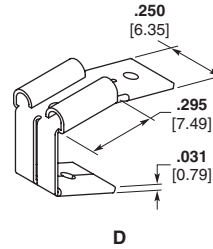
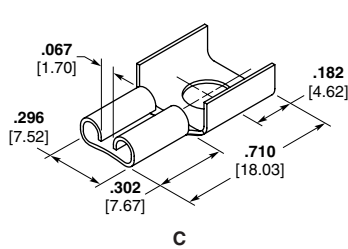
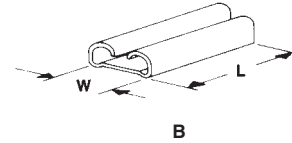
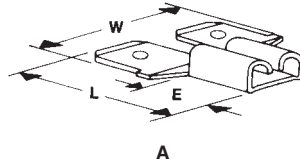

Style	Stock Thickness	Dimensions			Material and Finish	UL	SP	Terminal Part No.
		W	L	E				
A	.018 0.46 Recpt.	.650 16.51	.770 19.56	.305 7.75	Brass	X	X	61765-1
	.032 0.81 Tabs				Tin Plated Brass	X	X	61765-2 ¹
B	.018 0.46	.300 7.62	.700 11.78	—	Tin Plated Brass	X	X	61810-2
						X	X	63918-1 ²
C	.016 0.41	—	—	—	Nickel Plated Steel	—	—	151302-2
	.016 0.41	—	—	—	Brass (90°)	—	—	152422-1
D	.016 Recpt. 0.41	—	—	—	Brass	—	—	726308-1
	.032 Tabs 0.81							
E	.018 Recpt. 0.46	.301 7.65	.705 17.91	.305 7.75	Brass	X	X	1742597-1 ³
	.032 Tabs 0.81							

¹ No tab stop on receptacle.

² Fits .025 [0.64] thick tab.

³ .187 [4.75] tab — .250 [6.35] receptacle.

187 Series

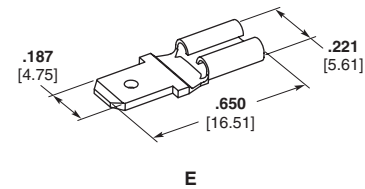
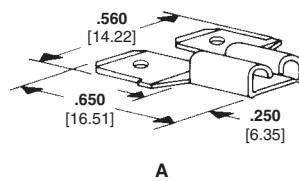

Style	Stock Thickness	Receptacle Fits Tab	Material and Finish	UL	SP	Terminal Part No.
A	.013 Recpt. 0.33	.020 0.51	Tin Plated Brass	X	X	61045-2
	.020 Tabs 0.51					
	.013 Recpt. 0.33	.032 0.81	Tin Plated Brass	X	X	63699-1
	.032 Tabs 0.81					
E	.013 Recpt. 0.33	.032 0.81	Tin Plated Brass	X	X	1217933-1
	.032 Tabs 0.81					

Note: All part numbers are RoHS compliant.